

**MecALAC**

**12 MTX**



**12 MTX**  
**MecALAC**





Innovation moves mountains; it makes the world turn. We will never stop coming up with new features, striving to improve our current technology and adapting to changing realities and constraints faced; we will excel. Innovation lies at the very core of what our company stands for.

**OUR TRADITION**

**INNOVATION  
IN MOTION**

**12 MTX**



  
étoile  
observateur design  
2015



# SIMPLICITY + VERSATILITY = PROFITABILITY

## OUR VISION

Expertise is born out of experience. Ours is based on the concept that you cannot even begin to consider profitability without first taking into account ease of use combined with operational versatility. When just one driver operating just one machine can handle a wide range of tasks on the same work site with no complicated handling maneuvers to worry about, you begin to completely reconsider what you can achieve in the time you have to work with.



DIGGING



LOADING

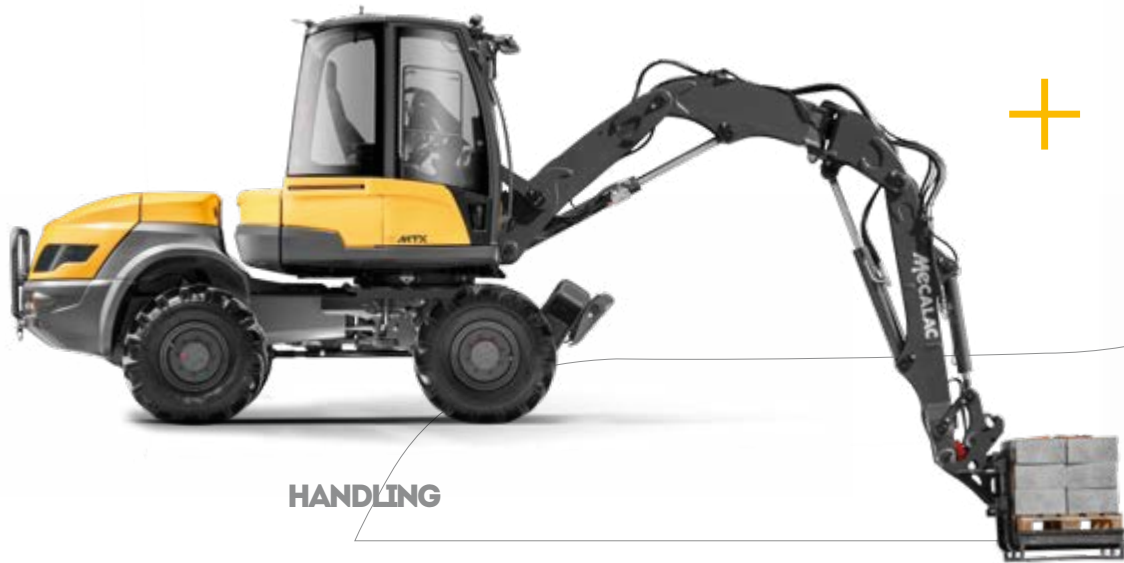

**HANDLING**



**TOOL CARRIER**





Combining proactive listening and practical, relevant industrial solutions is the Mecalac approach, meaning we can better size and customize our offers and machines. Our single professional aim is to be partner in the continuous success of each one of our customers and to ensure our products serve as good ambassadors for their companies.

## **OUR MISSION**

# **OFFER EACH CUSTOMER THE SOLUTION THEY NEED**







## OUR CONVICTION



The best that technology has to offer is useless without a composed, well-rested and focused human operator sat in the driver's seat. Making him/her feel comfortable and confident by maximizing cockpit safety is vital to generating rewarding working conditions and fostering entrepreneurship.





**PEOPLE ARE THE TRUE  
POWERING FORCE  
BEHIND ANY WORK SITE**

## THE UNIQUE CONCEPT BEHIND THE 12MTX GIVES SYNERGY A NEW MEANING.

The 12MTX could be considered Mecalac's calling card: innovation, technology, choice of materials and mechanical intelligence are at the forefront of our design in an attempt to continuously improve our products and provide solutions to the constantly evolving needs of our customers. Where the Mecalac 12MTX on wheels preserves the core yet ground-breaking features which have made the base concept such a success, it can now offer various improvements for even better ergonomics, safety, flexibility, functionality, and reactivity. For both urban and suburban environments, as well as the individual demands of your work site, the 12MTX guarantees maximum profitability thanks to its unprecedented performance and simplicity of use, ushering in a new generation of compact, versatile equipment for the construction sector.

# SUMMARY



Section 1

## 13 DRIVING



Section 2

## 21 DIGGING



Section 3

## 27 LOADING







Section 4

### 33 HANDLING



Section 5

### 39 TOOL HOLDER



Section 6

### 45 12MTX & OPTIONS



Section 7

### 49 ATTACHMENTS



Section 8

### 51 TECHNICAL DATA

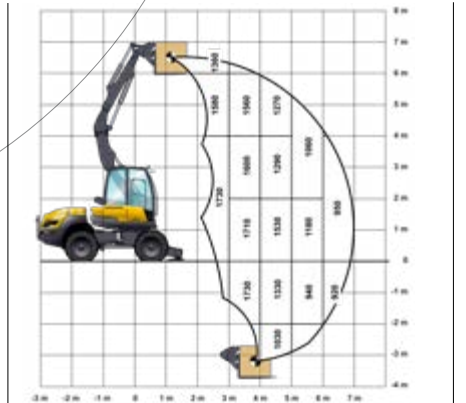







Section 1

Behind the controls of the 12MTX, the driver has a perfect view of the work site and can simply, effectively, and independently perform a number of actions and tasks in the safest of environments. From the incredibly spacious cab to the redesigned steering wheel, heating and air conditioning, sliding swing door, refrigerated storage space, and extendable steps, not to mention intuitive piloting and other customizable parameters, the 12MTX can only be described as revolutionary.

**SIMPLICITY  
IS WHAT  
DRIVES US**

## DRIVING

# MORE+ & MORE

- SINGLE SELECTOR, AN EXCLUSIVE MECALAC FEATURE
- CONTROLS CUSTOMIZATION
- ERGONOMIC, ULTRA-SPACIOUS CAB
- EXTENDABLE STEPS



## INTUITIVE, PRECISE STEERING

With the 12MTX, it's virtually impossible for the driver to make mistakes. Using the selector, every machine function can be viewed in real time on the 7" color screen. Both reassuring and effective, there is an actual programmable computer on board which allows users to





customize and retain driving parameters for three different drivers in addition to the preset factory mode. On each side, left and right consoles offer great convenience and practicality of use for the multiple functions and options shown in easily readable and understandable icons.

## PARKING OR ON-ROAD MODE. TRULY EFFORTLESS!

Using the selector, you can change .from on-road mode to parking mode in one single movement. Forget about the high beam headlights and rotating beacon, unlocking axles and inspection regimes. There's no need to worry about the brakes, switching the gearbox into idle, deactivating the foot throttle and locking controls. Everything is done instantaneously and automatically by selecting the desired application, ensuring a perfect and incredibly safe driving experience on your work site.





The figures

[61FT<sup>2</sup>]

**5.7M<sup>2</sup>**  
**OF TOTAL  
VISIBILITY**

## **SEE FURTHER BEYOND**

Constantly keeping an eye on what you're doing with the machine while trying to focus on the work site is a high responsibility. With the 12MTX, we've made the driver's direct line of vision a priority. At the rear the hood lines have been studied and improved, the rounded window is now a single pane for less obstructed view, and the Mecalac boom lifting system, once engaged, frees up vision on the sides. The windshield is fully removable and, together with a door window which can be opened, means the driver can remain in constant contact with the outside if needed. And thanks to the multi-level steering column, the steering wheel is never within your visual perimeter of the working area. Then, when you add the rear view mirrors and cameras\* to the equation, the cab could only be described as... visionary.

\*optional attachments. See pages 45-46-47



## COMFORT AND SPACE

Not only have we improved the comfort of the driving experience, we've redefined it. In addition to the more spacious cab and adjustable pneumatic seat\*, the driver, regardless of his/her size, is sure to be more comfortable than ever: heating and air conditioning\*, soundproofing and a sunroof, wide armrests and multiple storage compartments, tinted windows and a redesigned wheel steering, a sliding swing door and even a refrigerated compartment\*. From the perfectly integrated threshold to the molded floor mat, no detail has escaped Mecalac when designing this cab which meets all interior and external performance needs.

*\*optional attachments. See pages 45-46-47*





# CONNECT



**SAFETY?  
EVERYTHING  
YOU NEED  
WITH OPTIONS  
TO SPARE**

Optimizing safety for both the operator as well as the whole of site personnel was at the core of the specifications we wished to implement. In the end we've managed to minimize the risk of accidents occurring by setting the 12MTX up with innovative standard equipment. In addition to placing the cab on the right-hand side, allowing to carry out service tasks from the ground, the oscillation lock on the brake pedal automatically ensures machine safety while the driver is focusing on the task at hand. As for the integrated cameras which were added by popular demand, they are perfectly integrated with the control monitor to display external views once the reverse gear is engaged. Another innovation, Mecalac introduces CONNECT, a new quick coupler system. It can be operated from the cabin. Designed to work in both directions, the loss of an attachment is virtually impossible, during the locking or when working in excavator mode or in loader mode. It's the safest and most performing quick coupler system on the market.



## “FEET ON THE GROUND” MAINTENANCE



## STEPPING UP TO SAFETY

Stepping up and down from the cab is the source of too many work site accidents. There should not have accidents anymore due to slipping on a tire while climbing into the cab. No issues anymore, thanks to Mecalac's patented solution which is now standard for the 12MTX. The step automatically unfolds below the cab entry whenever the operator lifts the console to exit the vehicle. The driver steps out to find a ledge directly underneath his/her feet. When lowering the console, the step slots back perfectly within the machine's width. Whoever said you had to sacrifice safety for comfort?







12 MTX





The only articulated excavator in the world has completely changed how we view the various methods of digging. Working in extremely tight and compact areas, this model has proved that a machine is only as effective in an urban environment as it is flexible, powerful and versatile. With the 12MTX you no longer have to worry about constantly maneuvering to be in the ideal position for sites where space is tight, in sensitive environments or when opening trenches behind a barrier or along a wall. All of this without infringing on thoroughfares and with remarkable, visible precision.

# DETOUR-FREE DIGGING

**DRIVING**

**MORE+**  
**& MORE**



- USEFUL COMPACT DESIGN
- INCREASED WORKING AMPLITUDE
- UNIQUE IN TERMS OF MANEUVERABILITY
- EXCELLENT VISIBILITY





## AT ARM'S LENGTH

The unique kinematics built-in to the Mecalac articulated boom allow you to work from either directly beside the vehicle to up to 7m (23') away in a single operation. Amplitude combined with record precision and working power allows for easy and effective digging operations, whether up close or far away. Efficiency is a standard feature with the 12MTX!



+

## COUPLE UP!

The patented Mecalac cylinder coupling function, allows to synchronise the boom cylinders for perfect movement coordination and precision. Selectable for both digging and loading operations, it makes driving and handling easy, regardless of whether the operator is a novice or more experienced. Whether engaged or otherwise, it's yet another powerful feature along for the ride.







## FREEDOM OF MOVEMENT

With a full 360° swing within 2.80m (9'2") and an outstanding boom tilt angle (140°), the 12MTX only needs one road lane in urban environments to carry out its work. Traffic can continue with a minimum of interruptions, with the operator being able to work closer to the various obstacles he/she comes across (buildings, street lighting, plants, etc.) while ensuring pedestrians are not placed at risk. The 12MTX offers efficient, effective compactness, with 100% of its operations and functions available and minimum impact on the overall working environment for inner city work sites.





## MECALAC PATENTED CYLINDER COUPLING FUNCTION

### MOVEMENT-FREE DIGGING

Weighing nearly 10 tons and featuring unparalleled dexterity, the 12MTX is the champion in your corner for work sites where room to maneuver is at a premium. Featuring reduced, well-integrated offset and a three-piece articulated boom, allowing you to work outside of the machine footprint area, it's the perfect combination of power and flexibility. Even performing digging from behind an obstacle, for example with the machine positioned parallel to a wall, is no problem, all the while offering excellent economy of movement.







If you are in the market for a powerful, quick, precise loader, then look no further than the 12MTX. Whether the bucket comes equipped with or without teeth or working with a 4x1 multipurpose bucket, the 12MTX rises to the occasion each time: being able to take on loads without clogging up roads or construction sites or having to perform an excessive number of maneuvers to reach its goal. All of this with XXL loading capacity!

**LOADING**  
**MORE EFFICIENCY**  
**LESS EFFORT REQUIRED**







**LOADING**

**MORE+**  
**& MORE**



- FULL 360° UPPER STRUCTURE ROTATION
- UNIQUE DUMPING HEIGHT
- BUCKET VOLUME OF 750 LITERS
- STATIC LOADING



## WITH THE WORK SITE IN FULL VIEW

With the boom positioned to the left of the cab and even with a large capacity bucket dumping into a 5m (16'5") high truck, the operator maintains perfect visibility during each handling operation. The kinematics built-in to the Mecalac articulated boom mean loading and unloading maneuvers can be performed such that the operator's field of vision is not obscured by the boom structure. Combining safety with efficiency, wasn't that the secret formula for profitability?







Up to

**5M** [16'5"]

**IN HEIGHT  
DURING LOADING  
AND DUMPING  
OPERATIONS**

## 360° OF FREEDOM

There's nothing better than maximum efficiency. Thanks to full 360° rotation, the 12MTX optimizes work site operations while minimizing machine movements. Wave good-bye to unnecessary movement and handling operations, say hello to speed and efficiency. Sanding, loading, dumping—there's nothing it can't do. Static loading is also an option due to the dipperstick cylinder being placed in a lower position, offering unmatched strength for both lifting and thrust. Whether working from a pivot position or stationary, the 12MTX will get your work site moving at a faster pace.



**ROTATION  
AT 360°**



## RANGE AND VERSATILITY

The excellent range provided by the Mecalac three-piece articulated boom is a revolution for loading operations: dip effortlessly into the back of a truck, backfill from behind an obstacle, recover material from underfloor spaces (e.g. pits, swimming pools, etc.) all with unprecedented ease thanks to the Mecalac boom and a fully rotational upper structure. There's also the added perk of cleanliness: you no longer have to dump a truck's worth full of sand, dirt or gravel prior to using the materials, again thanks to the 12MTX rotational upper structure. It's just one more reason why the 12MTX is your best bet for overcrowded work sites or pedestrian areas.

## STAY IN CONTROL

At all times the operator is in complete and simple control of the 12MTX. The controls located on the joysticks operate the loader interface allowing selection of the travel direction. Additionally engine speed can be controlled using the inching foot pedal which also functions as a driving interface. And, for optimal driveability, the driver/operator has access to all operations on demand without even releasing controls. The operator has virtually complete control over the driving direction and upper structure rotation at his/her fingertips.







Lifting, laying, moving, unloading, storing... The 12MTX sets the pace for work site logistics and makes execution easy. Up or down, whatever the challenge-the 12MTX can handle it and then some more. It's capable of working side-by-side with trucks, or carrying a pallet loaded with material and laying it to rest on the other side of a wall, or even next to the machine itself, whatever you need. Ultra-flexible, versatile: the 12MTX brings profitability and a touch of comfort to complex work sites and/or confined spaces.

# HANDLING

## HEIGHTENED PERFORMANCE

### FROM +6M TO -3M [+19'8" TO -9'10"]







## HANDLING

**MORE+**  
**& MORE**

- LOW CENTER OF GRAVITY
- LIFTING POWER
- UNDERFLOOR LOAD HANDLING
- STATIC LOADING



## UNRIVALED WEIGHT/ LIFTING POWER RATIO

The unique architecture behind the 12MTX makes it a powerful and precise piece of handling equipment, capable of lifting up to 4 tons. The center of gravity has been positioned to exert a positive influence on lifting performances. The engine is located in the rear of the vehicle, offering a removed counterweight for greater freedom of handling and movement with larger loads. This weight design is particularly notable on work sites where handling applications are performed.







The figures

[FROM -9'10" TO +19'8"]  
**FROM -3M  
TO +6M**

## REMOVING THE PROBLEM OF REMOVALS

Reducing handling time is too often a headscratcher at best and an unsolvable puzzle at worst, with the 12MTX ready to step in and revolutionize logistics for your work site. You can now move pallets directly into pools or onto foundations, with the machine retracting the fork, leaving the pallets in place. The articulated boom even allows you to handle the pallet in minimum distance to the machine. Could it be any easier?



**LOADS  
OF UP TO  
4 TONS**

### **TIRES FIRMLY PLANTED**

Despite weighing over 9 tons, the 12MTX is capable of taking on all types of terrain, regardless of the weather. We understand that work sites often have their ups and downs, and the stability of the machine in movement is of the utmost importance. With its articulated undercarriage, low center of gravity, 4-wheel drive and 5 different sets of tires at choice, the 12MTX is sufficiently grounded to ensure precision and control over where you're going. The driver can comfortably carry out his/her work, free from any rebound effects whilst in motion. And regardless of the maneuvers being performed or the surrounding environment, the 12MTX does an extraordinary job of keeping its balance.







The tool holding function comes into its own with the 12MTX. No longer just simple attachments, advances have been made in increasing simplicity as well as efficiency thanks to dedicated innovations. The memory function of several attachments hydraulic flow rates, making repeated manual settings unnecessary. The speed control function allows the driver to individually set the maximum speed required. Combining the benefits of a tool carrier with a perfectly balanced and articulated undercarriage along with our boom and dipper performance while being able to adapt to the particular demands of each tool and making work that much easier—who else but Mecalac?

# TOOL CARRIER

## THE QUIET STRENGTH OF VERSATILITY







**TOOL CARRIER**



**MORE +  
& MORE**

- BALANCE
- SPEED MANAGEMENT
- MANEUVERABILITY
- HYDRAULIC POWER



## AN ATTACHMENT TO PROFITABILITY

Turning the 12MTX into a planer, flail mower, sweeper, or mounting a hydraulic hammer in seconds with minimum fuss is one of the great strengths of the Mecalac patented quick attach system. The driver is able to change each hydraulic attachment easily, safely, and with complete control, leading to a significant increase in productivity which positively effects the profitability of your working site.



+

## MEMORY MASTER

Using the flow rate memory function, the 12MTX's abilities as a tool carrier become even more impressive: you can save up to 6 different profiles/tools for quick, easy, and intuitive switching which makes the operator's job that much easier, in addition to no longer having to spend time recalibrating settings and the impact on productivity and work comfort this entails.







**+**  
The figures **[0.19 TO 19.9 MPH]**

**0.3** <sup>KM/H</sup>  
**TO 32** <sup>KM/H</sup>  
**→ AT A CONSTANT SPEED**



## **NO NEED TO THINK TWICE**

Why should you have to compromise between a steady flow and precise progress? The new speed control system allows for ultra-precise adjustment to the constant maximum speed: from 0.3, 0.6, 0.9 [0.19, 0.37, 0.56 mph]... up to a maximum of 32 km/h [19.9 mph]. The driver has complete control over the movement speed of the engine and can fully concentrate on operating tools. This innovation, which is easy to configure, enable, and disable exponentially raises the value of the 12MTX's tool holding function.





**COMPACTOR  
PLANER  
CUTTING BLADE  
HAMMER  
FLAIL MOWER  
TRIMMER  
...**

## THE CUSTOMIZABLE WORK SITE

With the 12MTX, comfort and precision come together when using hydraulic tools, taking full advantage of the technology developed for its digging and loading functions. The Mecalac boom structure allows you to set the work attachment in an optimal position to apply force in the right direction, preserving the state of the equipment used and limiting interruptions to traffic caused by the presence of the machine. The articulated undercarriage guarantees perfect maneuverability, reducing the amount of movement required and making getting around the work site that much easier.







The 12MTX comes standard equipped with a number of features, while at the same time remaining attentive to the specifications required by various different types of customers: landscape and earthwork contractors, public works professionals, municipal authorities, etc. So, from the color scheme to the choice of tires, heating/AC or cameras, not to mention to the various attachments, buckets, and hydraulic tools which can be used, there are many different ways to tailor your 12MTX to your brand and business.

# YOUR 12MTX & AVAILABLE OPTIONS

# 12MTX STANDARD EQUIPMENT

## UNDERCARRIAGE

Articulated with 4-wheel drive, each being of equal size and equipped with Alliance 405/70-20 14PR 317 tires, oscillating rear axle with cab-controlled lock, limited slip differential on both axles

Integrated oil-bath multi-disc brakes on both axles

Closed circuit hydrostatic transmission

Speed change, 0 to 32 km/h (0 to 19.9 mph) with exclusive Speed Control system to define the maximum speed

Outriggers separately proportionally and electrically controlled

## ENGINE

DEUTZ TCD 3.6 "common rail" turbocharged engine, with chilled air inlet, 4 cylinders, water cooling. Engine meets U.S. EPA Tier 4 Final / EU Stage V emissions standards.

## KINEMATICS

Variable adjustment boom with 4 parts; boom cylinder assembly on parallelogram; hydraulic left/right offset; stick

CONNECT hydraulic quick attach, a Mecalac exclusive

## LUBRICATION

Centralised, manual single point for the whole of the parallelogram boom

## 4 OPERATING MODES

4 operating modes: Park, Excavator, Loader and Road

Controls carried out via proportional, ergonomic joysticks

Advanced customization of various modes and controls

## THE CAB - COMFORT AND SAFETY

Cab access via an extendable step, a Mecalac exclusive

A 7" VGA color screen for control over safety components and machine functions.

Cab with wide view and premium comfort and ROPS/FOPS standard-compliant with:

A sliding swing door, a Mecalac exclusive

A removable front windshield, partially or fully, an exclusive Mecalac feature

A sliding glass door

A roof hatch

Steering column with three adjustment controls: 2 for tilt, one for steering wheel height

Storage space with separate container

ISO 10263-compliant heating with 6 separate vents

Position adjustable, seat adapts to the shape of the operator

Radio-ready installation and 12V power supply

## NEW QUICK COUPLER: CONNECT

The new Mecalac quick coupler is compliant with the latest regulations of the EN-471-1 and introduces a new standard, anticipating an even greater safety.



### PRODUCTIVITY



Reversibility as standard, adapted to all attachments and to the four functions of our machines

Simple pick-up of attachments, optimum understanding and visibility, in both directions

Maintenance-free, no need for additional lubrication, reduced risk of failure

The advantage of a compact and light coupler was used to enhance the bucket volume: +10%

Transport of 3 digging buckets (400-600-900) on the ditch-cleaning bucket\*

\* Not allowed on roads.

### SAFETY

Impossible for a bucket to drop, once lifted off the ground no matter if locked or not, regardless of the direction of the tool, a "hook" system preventing a drop of the bucket, integration of a safety-valve in the cylinder

Continuous detection of the cylinder position, "real time" measurement of the locking of the accessory, associated with an acoustic warning signal in the cab

Automatic hydraulic compensation of play by an over-dimensioned length of the cylinder rod

Simple user interface, avoiding any risk of mal-operation

### RELIABILITY

Use of 500 hb steel for the eyehooks, the steel used for the buckets is of the worldwide highest durability

100% Mecalac: the machine, quick-coupler and attachments: designed to work together.

CONNECT is dedicated to Mecalac

**Standard and optional equipment may vary.  
Consult your Mecalac dealer for details.**

## OPTIONS TO TAILOR YOUR 12MTX TO YOUR NEEDS

### CUSTOMER COLORS

If you'd like to have your Mecalac 12MTX painted in your company's colors? Personalize your Mecalac with your own RAL codes.

Colors samples



### TIRES

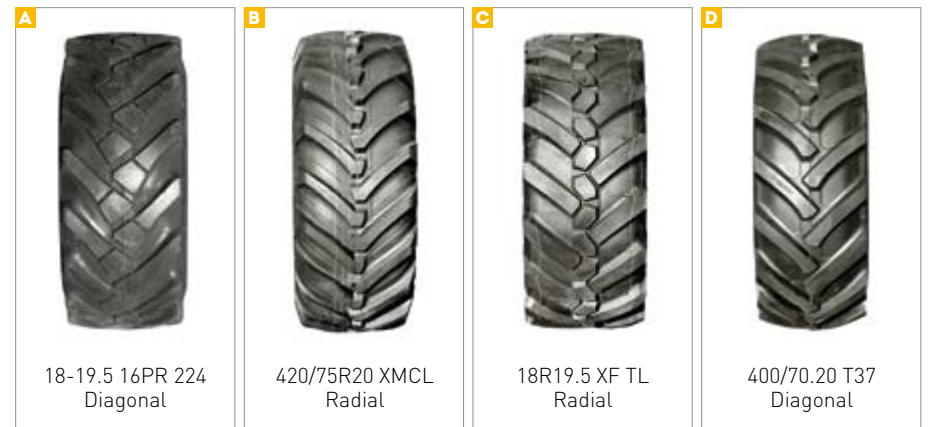

### QUICK COUPLERS

CONNECT quick coupler fitted with a hook

Direct coupling system, for mounting attachments on the stick with pins.

### ADDITIONAL COUNTERWEIGHT +400KG (881 LB)

### ELECTRIC DIESEL REFUELING PUMP

### FLEET MANAGEMENT PREDISPOSITION



# OPTIONS

## TO TAILOR YOUR 12MTX TO YOUR NEEDS

### THE CAB - COMFORT AND SAFETY

- 1 Heating and air conditioning
- 2 Heated pneumatic seat
- 3 Double pedals (inching/brake)  
Rotating beacon, traditional or LED



- 4 Additional front working light, LED  
Rear working light, LED
- 5 Cabin sun visor
- 6 Radio 2 speakers, USB, Bluetooth  
Anti-theft device - electronic immobilizer with 6 keys  
3 or 4 safety valves  
Lifting-type approval for handling activities - France only  
Back-up alarm, traditional or white noise



## ENGINE

Diesel Particulate Filter, DPF (standard in Europe)

Automatic engine idle shutdown

## AUXILIARY LINES

**A** Auxiliary Line 1 (standard, proportional)

**B** Auxiliary Line 2: Diverted offset cylinder for rotating function of a clamshell

**C** Auxiliary Line 3: Diverted bucket cylinder for opening / closing function of a clamshell

**D** Hammer return line

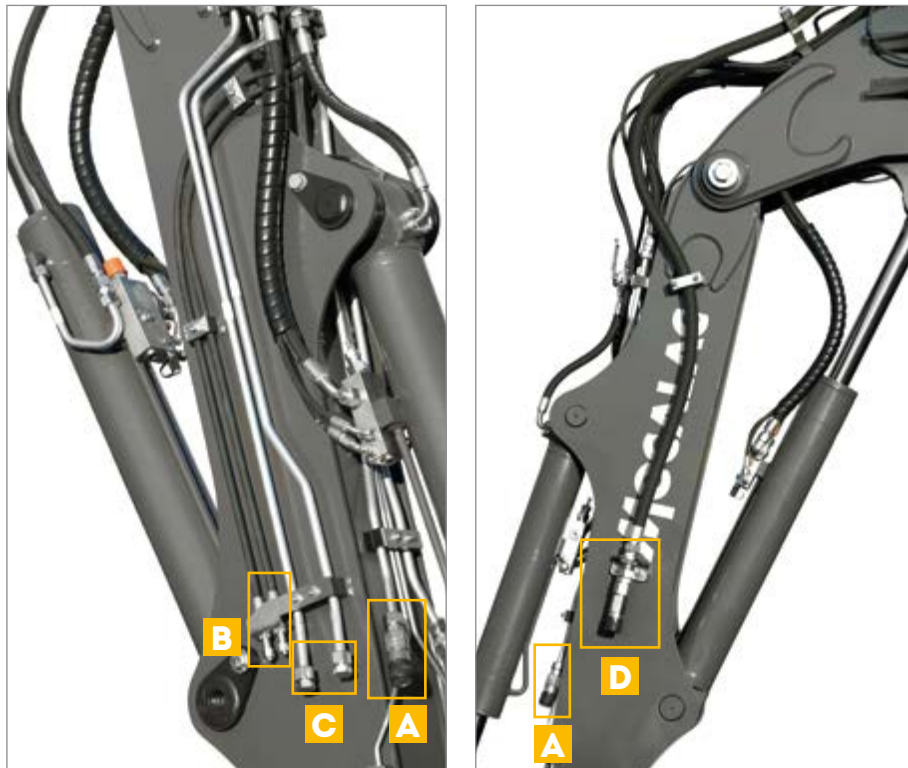

Standard and optional equipment may vary.  
Consult your Mecalac dealer for details.

## LUBRICATION

Centralized, manual, single point lubrication for the boom and stick

Centralized automatic lubrication for the boom and stick

Biodegradable hydraulic oil

## REAR SAFETY BAR



## PALLET FORK OR OTHER 3<sup>RD</sup> POINT TOOLS ADAPTATION PREDISPOSITION FOR OUTRIGGERS







## WORK TOOLS AVAILABLE WITH CONNECT QUICK COUPLER

### DIGGING BUCKETS

TYPE	WIDTH mm (ft in)	number of teeth	VOLUME l (yd³)	WEIGHT kg (lb)
DIGGING BUCKET with teeth	350 (1'2")	3	150 (0.20)	204 (449)
	450 (1'6")	3	190 (0.25)	222 (481)
	600 (2')	3	275 (0.36)	255 (562)
	750 (2'5.5")	4	360 (0.47)	292 (643)
	900 (2'11")	5	450 (0.59)	328 (723)
	1200 (3'11")	5	630 (0.82)	393 (866)
DIGGING BUCKET with no teeth	350 (1'2")	-	150 (0.20)	188 (414)
	450 (1'6")	-	190 (0.25)	207 (456)
	600 (2')	-	275 (0.36)	239 (526)
	750 (2'5.5")	-	360 (0.47)	272 (599)
	900 (2'11")	-	450 (0.59)	304 (670)
	1200 (3'11")	-	630 (0.82)	368 (811)



### LOADER BUCKETS

TYPE	WIDTH mm (ft in)	number of teeth	VOLUME l (yd³)	WEIGHT kg (lb)
LOADER BUCKET with teeth	2250 (7'5")	7	750 (1.00)	412 (908)
TOOTH PROTECTION	2250 (7'5")	-	-	19 (41)
LOADER BUCKET with no teeth	2250 (7'5")	-	750 (1.00)	390 (859)
BLADE GUARD	2250 (7'5")	-	-	10 (22)

### 4X1 BUCKET

TYPE	WIDTH mm (ft in)	number of teeth	VOLUME l (yd³)	WEIGHT kg (lb)
4X1 BUCKET with teeth	2200 (7'3")	7	540 (0.71)	640 (1410)
TOOTH PROTECTION		-	-	11 (24)
4X1 BUCKET with no teeth	2200 (7'3")	-	540 (0.71)	617 (1360)
BLADE GUARD		-	-	7 (16)
BOLTED COUNTERBLADE FOR 4X1 BUCKET with no teeth 7 boreholes - center-to-center borehole distance 330	2200 (7'3")	-	-	62 (136)
4X1 BUCKET CONNECTION SET, 2 FLEXIBLE JOINTS	-	-	-	5 (11)

# MECALAC ATTACHMENTS



## PALLET FORK

TYPE	Specifications	WEIGHT kg (lb)*
PALLET FORK	to be used with 4 safety valves	351 (773)
PALLET FORK USING OUTRIGGERS adaptation predisposition with 3 <sup>rd</sup> point for other hydraulic tools	to be used with 4 safety valves	406 (895)

## NARROW BUCKET

TYPE	WIDTH mm (ft in)	number of teeth	VOLUME l (yd³)	WEIGHT kg (lb)*
NARROW BUCKET	300 (1')	3	80 (0.10)	219 (482)

## DITCHING BUCKET

TYPE	Specifications	WIDTH mm (ft in)	VOLUME l (yd³)	WEIGHT kg (lb)*
DITCHING BUCKET		1800 (5'11")	400 (0.52)	350 (771)
BOLTED COUNTER BLADE for DITCHING BUCKETS	borehole center-to-center distance 152.4 (6")	1800 (5'11")	-	47 (103)

## MECALAC MR60 TILTROTATOR

TYPE	Specifications	PIN to PIN HEIGHT mm (ft in)	ROTATION TORQUE Nm (lb.ft)	WEIGHT kg (lb)* 1xCONNECT
MR60 TILTROTATOR no grab	Twin CONNECT configuration, 2x 40° 2 low-flow auxiliary functions	686 (2'3")	8200 (6,050)	574 (1,270)
MR60 TILTROTATOR with grab module	Twin CONNECT configuration, 2x 40° 1 low-flow auxiliary function	686 (2'3")	8200 (6,050)	683 (1,510)

## MECALAC TILTROTATOR DEDICATED GRADING BUCKET

TYPE	Specifications	WIDTH mm (ft in)	VOLUME l (yd³)	WEIGHT kg (lb)*
GRADING BUCKET FOR TILTROTATOR MR60	Dedicated bucket for finishing works	1500 (4'11")	570 (0.75)	455 (1005)
BOLTED COUNTERBLADE FOR GRADING BUCKET	borehole center-to-center distance 152.4 mm (6 in)	1500 (4'11")	-	43 (95)

## TILT DITCH CLEANING BUCKET

TYPE	Specifications	WIDTH mm (ft in)	VOLUME l (yd³)	WEIGHT kg (lb)*
TILT DITCH CLEANING BUCKET	2x Linear cylinders, 2x 45°	1800 (5'11")	516 (0.67)	725 (1,598)
BOLTED COUNTER BLADE	borehole center-to-center distance 152.4 mm (6 in)	1800 (5'11")	-	51 (112)

## DIGGING BUCKET WITH GRAPPLE

TYPE	Specifications	WIDTH mm (ft in)	VOLUME l (yd³)	WEIGHT kg (lb)*
GRAPPLE BUCKET	2 hydraulic thumbs	900 (2'11")	450 (0.59)	492 (1085)

## HANDLING PLATE WITH HOOK

TYPE	Specifications	WEIGHT kg (lb)*
HANDLING PLATE with hook	to be used with 3 safety valves	64 (141)

## HANDLING JIB

TYPE	Specifications	WEIGHT kg (lb)*
HANDLING JIB	length 4100 mm (13'5"), lifting capacity 500 Kg (1102 lb) to be used with 4 safety valves	192 (308)

## CLAMSHELL BUCKET SUPPORT

TYPE	WEIGHT kg (lb)*
SUPPORT PIECE FOR CLAMSHELL BUCKET	67 (148)

## RIPPER TOOTH

TYPE	WEIGHT kg (lb)*
RIPPER TOOTH	192 (423)

## SKID STEER ADAPTER

TYPE	WEIGHT kg (lb)*
ISO 24410 mounting hitch for Universal Skid steer attachments	127 (280)

## HAMMER PLATE

TYPE	Specifications	WEIGHT kg (lb)*
HAMMER PLATE no boreholes	-	104.5 (230)
HAMMER PLATE with boreholes	contact your dealer	105.5 (233)

\*Weight taken with machine in full running order with full fuel, standard tires and operator.





# YOUR 12MTX TECHNICAL DATA

## WEIGHT DATA

Weight taken with machine in full running order with full fuel, standards tires and operator	9700 kg (21,384 lb)
--	---------------------

## ENGINE

Turbo charged engine with intercooler, EGR valve, catalytic converter (DOC) and Selective Catalytic Reduction (SCR) systems, complying with emissions standards	EU Stage V U.S. EPA Tier 4 Final*
Brand 4 in-line diesel cylinders	DEUTZ TCD 3.6L4

Power: DIN 70020	85 kW (115 hp - 114 imperial hp) to 2200 rpm
------------------	---

Max. torque	460 N.m (339 ft.lbf) at 1600 rpm
Displacement	3621 cm <sup>3</sup> (221 in <sup>3</sup> )
Cooling system	Water
Dry/cartridge cyclonic air filter	•
Machine external sound level	101 dB
Fuel tank capacity	140 l (37 gal)

## ELECTRICAL SYSTEM

Voltage	12 V
Batteries	100 Ah
Alternator	95 A
Starter	3,2 kW
Electric sockets sealed	•

## UNDERCARRIAGE

Articulated type	•
Inside turning radius	2.63 m (103.5 in)
Outside turning radius	4.91 m (193.3 in)
Front chassis fitted with 2 separate front outriggers acting on proportional control	•

\*Depending on your Local Legislation - Environmental Protection Agency (EPA)

## TRANSMISSION DATA

Closed hydrostatic center with Senso Drive automotive type automatic regulation	•
Electronically controlled traveling direction reverser located under right joystick	•
Inching command allows the diesel engine to constantly rev to reduce speed until a complete stop is reached: this function is governed by a pedal which also controls the braking function	•
Hydraulic motor	150 cm <sup>3</sup> (9 in <sup>3</sup> )
Pump	182 l/min (48 gpm)
Hydraulic variable displacement pump and motor allow for a continuously variable transmission rate over the whole speed range of the machine	•
Continuously variable speed	i.e. 0-32 km/h (19.9 mph)
Max. pressure	430 bar (6,237 psi)
Max. traction force	5800 daN (13,039 lbf)
Gradeability	78 %

## AXLES AND WHEELS

4-wheel drive	•
Standard: 405/70-20 tires	•
Drive axle rigid over front chassis	•
Drive axle over rear chassis oscillates to +/- 10° and blocking by the hydraulic cylinders	•
Transfer box with single request acting directly on the front and rear axles via a transmission shaft with a limited-slip differential on the two axles	•

## BRAKES

Double circuit central braking unit	•
Integrated oil-bath multi-disc brakes for each axle	•
Inching brake acting on all 4 wheels	•

## UPPERCARRIAGE

Full 360° rotation	•
Internal ring gear drive	•
Rotation via hydraulic motor (with automatic disc braking)	•
SHOCKLESS type dampened crossover valve for upper carriage rotation movement and soft stop	•
Rotation speed	9 rpm
Rotation torque	2210 daN.m (16,300 ft lbf)
Hydraulic motor	750 cm <sup>3</sup> (45.8 in <sup>3</sup> )
Max. pressure	230 bar (3,336 psi)

## CAB

Glass cab with wide view and supreme comfort	FOPS/ROPS homologated
Cab mounted on 4 rubber silent blocks	•
Front windshield partially or fully removable	under the cab roof
Sliding door	•
Opening door window	•
Position adjustable, seat adapts to the shape of the operator	seat adjustable in both height and width with seatbelt
Controls integrated into consoles located on either side of the seat and adjustable relative to the seat	•
Water heating system complies with ISO 10263	high flow fan, high capacity for demisting and defrosting



CAB	DATA
Controls carried out via proportional, ergonomic joysticks	•
Electronic dashboard containing all safety and monitoring information, visual indicators and alarms	•
Fuel levels and coolant temperature indicated on the dashboard	•
Dashboard contains a color screen which automatically adapts contrast and light levels to current conditions	•
Front working light, LED	•
Rear storage area	•
Side and rear (cab rear) cameras	•

HYDRAULICS (circuit equipment and rotation)	
Variable displacement pump	max. 130 cm <sup>3</sup> (8 in <sup>3</sup> )
Maximum flow rate	165 l/min (44 gpm)
Maximum working pressure	310 bar (4,496 psi)
Active control power management	•
Proportional load sensing with individual balancing of each element: boom, adjustable boom, dipper stick, bucket and ancillary	•
Proportionality of functions always achieved irrespective of the pressure level of each element: "flow sharing"	•
Anti-cavitation overpressure relief valve in each element	•
Hydraulically-assisted proportional function controls using joysticks or foot pedals supplied at low pressure with emergency accumulator	•
Hydraulic system capacity	190 l (50 gal)
Hydraulic tank capacity	82 l (21.7 gal)

MACHINE DIMENSIONS	
A Overall length	4619 mm (15')
B Cab height	3064 mm (10')
C Height with boom retracted	3464 mm (11'4")
D Rear overhang	1407 mm (4'6")
E Wheelbase	2225 mm (7'3")
F Front overhang	933 mm (3')
G Hood height	1744 mm (5'7")
H Approach angle	53°
I Departure angle	30°
J Height under upper carriage	1165 mm (3'8")
K Ground clearance	354 mm (1'2")
L External width of the outriggers	2187 mm (7'2")
M Width at wheels, standard tires 405/70-20	2247 mm (7'4")
N Width in road position	2383 mm (7'8")

**NOTE**  
 METRIC MEASUREMENTS ARE THE CRITICAL VALUES  
 • 1 Litre = 0.26417 US Liquid Gallons  
 • 1 Litre = 0.21997 Imperial Liquid Gallons



# BOOM PERFORMANCE AND LIFTING CAPACITY

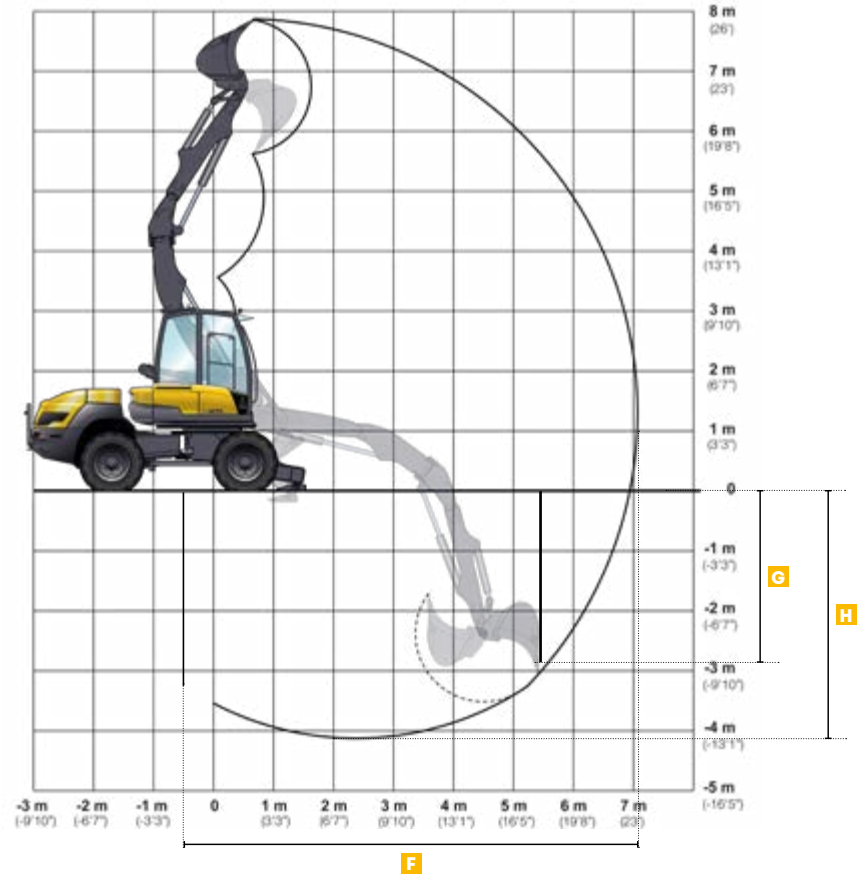

## MACHINE DIMENSIONS

<b>A</b> Boom offset, maximal	1859 mm (6')
<b>B</b> Outside dimension with max. offset	1239 mm (4')
<b>C</b> Rear tail swing radius	1385 mm (4'5")
<b>D</b> Front swing radius	1325 mm (4'3")
<b>E</b> Turning circle	2710 mm (8'9")

## PERFORMANCE

Break-out force	6150 daN (13,820 lbf)
Penetration/Tear-out force	3400 daN (7,640 lbf)
Lifting force with loading hook	4000 kg (8,820 lb) (value max.)
<b>F</b> Maximum reach	7125 mm (23'4")
<b>G</b> Vertical digging depth	2240 mm (7'3")
<b>H</b> Maximum digging depth	4100 mm (13'4")

## LIFTING FORCE WITH LOADING HOOK - STABILISERS ON GROUND

All the weights are given in kg (lb).

	FRONT		SIDE		FRONT		SIDE	
	2M (7 ft)	3M (10 ft)	4.5M (15 ft)	6M (20 ft)	FRONT	SIDE	FRONT	SIDE
<b>4.5M</b> (15 ft)	3280* (7,230*)	3280* (7,230*)	3190* (7,030*)	3190* (7,030*)	2460* (5,420*)	1530 (3,370)	-	-
<b>3M</b> (10 ft)	4000* (8,820*)	4000* (8,820*)	3480* (7,670*)	3480* (7,670*)	2910* (6,415*)	1490 (3,285)	-	-
<b>1.5M</b> (5 ft)	4000* (8,820*)	4000* (8,820*)	3480* (7,670*)	2740* (6,040*)	3100* (6,835*)	1310 (2,890)	1720* (3,790*)	740 (1,630)
<b>0M</b>	4000* (8,820*)	4000* (8,820*)	3480* (7,670*)	1960 (4,320*)	3080* (6,790*)	1240 (2,735)	-	-
<b>-1.5M</b> (-5 ft)	4000* (8,820*)	4000* (8,820*)	3170* (6,990*)	1860 (4,100*)	2580* (5,690*)	1090 (2,400)	-	-
<b>-3M</b> (-10 ft)	4000* (8,820*)	4000* (8,820*)	3270* (7,210*)	2080 (4,590*)	-	-	-	-

\* Loads limited by hydraulic capacity

## WORKING CONDITIONS

- On wheels with stabilisers on ground
- On horizontal, compact ground
- Equipment used without offset
- Front and rear frame aligned
- Without tools (bucket, shovel...) with handling plate and loading hook of 4 T
- 75% of the tipping load or 87% of the hydraulic capacity
- Maximum values determined for optimal position of boom and cylinders



All elements added to the end of the dipperstick must be taken into consideration when measuring the real lifting capacities in kg (lbs), particularly their positions and weights.

# LOADING



TECHNICAL FEATURES	DATA
Lifting power	4050 daN (9,105 lb) - acc to ISO 14397-2
Digging force	6400 daN (14,390 lb) - determined acc to Norm NF ISO 14397-2
Traction force	5970 daN (13,420 lb) - traction force of the machine
Tipping load with standard shovel forward with chassis fully turned	3550 kg (7,830 lbf) - tipping load acc to ISO 14397-1
Tipping load with standard shovel lateral with chassis fully turned	4050 kg (8,930 lbf) - tipping load acc to ISO 14397-1

MACHINE DIMENSIONS	
A Overall length	5617 mm (18'5")
B Dumping height	4077 mm (13'4")
C Loading height	4498 mm (14'9")
D Digging angle	40°
E Clearance under bucket	651 mm (2'2")
F Minimal turning radius upper structure	3600 mm (11'9")
G Minimum side dumping distance (bucket at 45°)	403 mm (1'4")
H Minimum side dumping distance (bucket at 90°)	78 mm (0'3")





**LIFTING CAPACITY WITH PALLET FORKS**

All the weights are given in kg (lb).

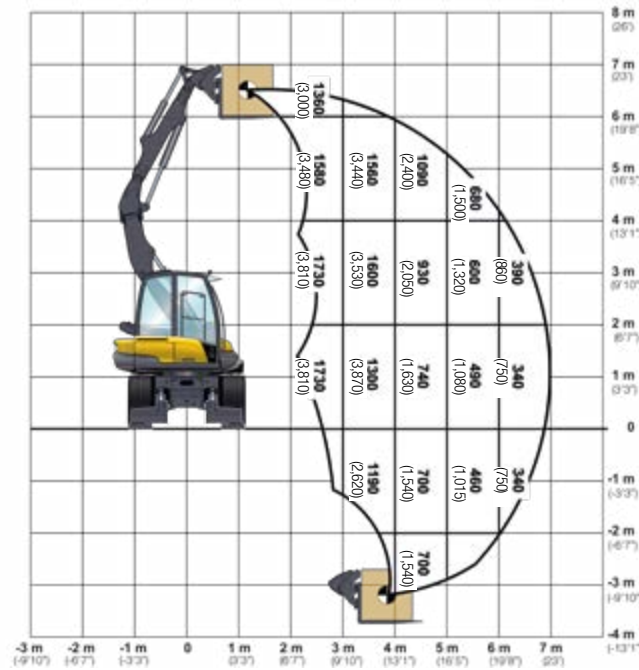
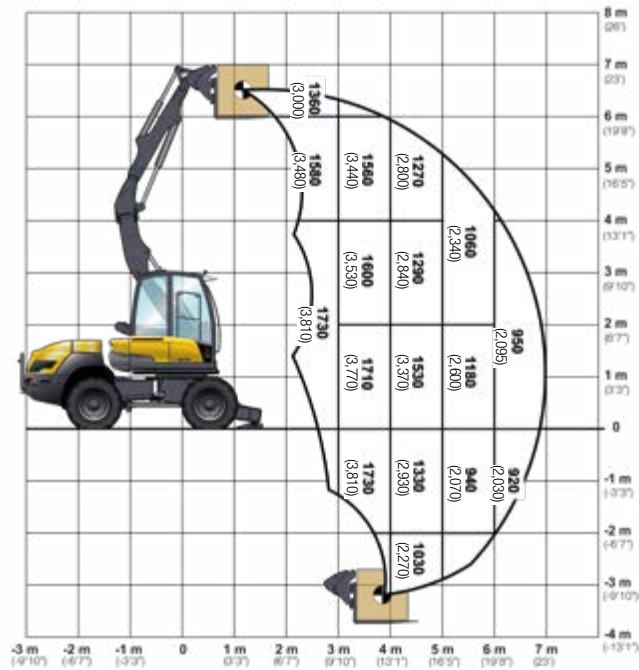

**WORKING CONDITIONS**

- On wheels with stabilisers on ground
- On horizontal, compact ground
- Equipment used without offset
- Front and rear frame aligned
- Equipped with loading forks

**ACCORDING TO ISO 10567**

- 75% of the tipping load or
- 87% of the hydraulic capacity

**LIFTING CAPACITY WITH LOADING FORKS DETERMINED FOR OPTIMAL POSITION OF BOOM AND CYLINDERS.**

**CAPACITY**

Lifting capacity of loading forks

2000 kg (4,410 lb) (value max.)

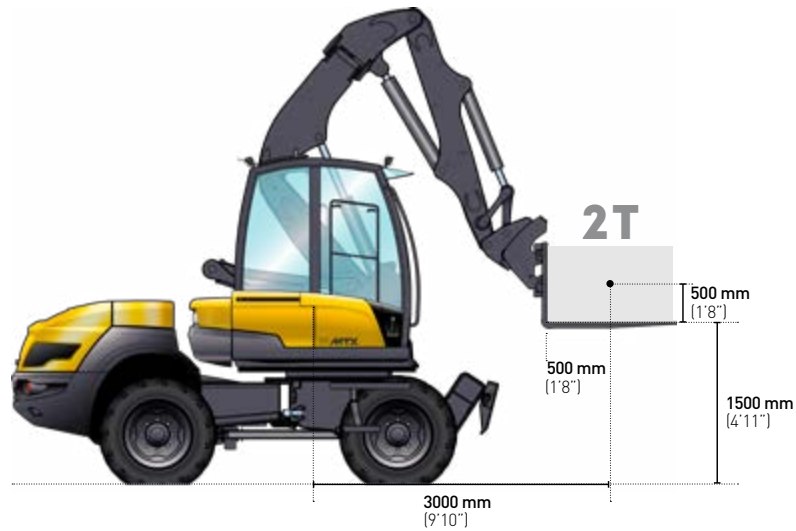

# HYDRAULIC ATTACHMENTS



## AUXILIARY LINE 1 - 85 KW (115 HP - 114 IMPERIAL HP) VERSION

Electro-proportional control integrated in the right joystick

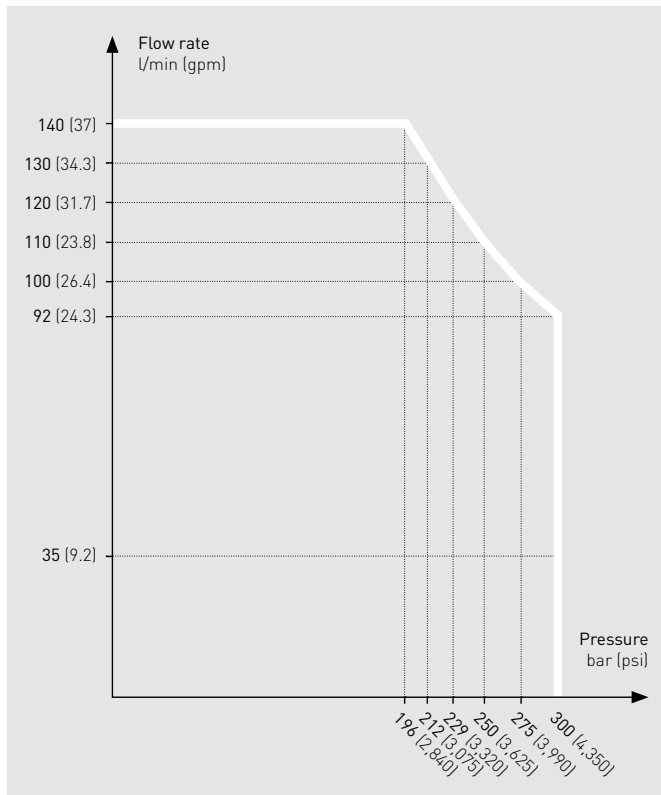

## AUXILIARY LINE 2 DATA

Circuit diverted from offset (clamshell rotation)	•
Flow rate	3-35 l/min (0.8-9.2 gpm)
Pressure	310 bar (4,500 psi)
Controls	Proportional as option

## AUXILIARY LINE 3 DATA

Circuit diverted from bucket (clamshell)	•
Flow rate	120 l/min (31.7 gpm)
Pressure	310 bar (4,500 psi)

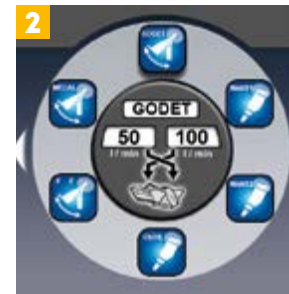
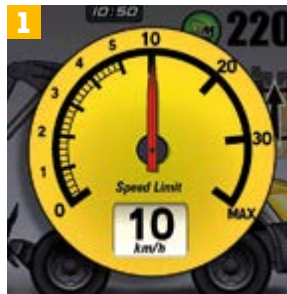

## 1 SPEED CONTROL - AVAILABLE RANGE IN KM/H

0.3 - 0.6 - 0.9 - 1.2 - 1.5 - 2 - 3 - 4 - 5 - 7 - 10 - 15 - 20 - 25 - MAX

## 2 CUSTOMISABLE PARAMETERS

Memory storage of flow rates and name of attachments

### NOTE

METRIC MEASUREMENTS ARE THE CRITICAL VALUES

- 1 Litre = 0.26417 US Liquid Gallons
- 1 Litre = 0.21997 Imperial Liquid Gallons



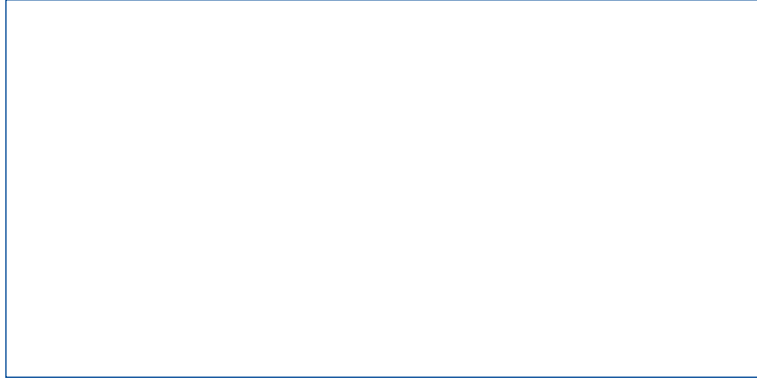

**MECALAC FRANCE S.A.S.**  
2, avenue du Pré de Challes  
Parc des Glaisins – CS 40230  
Annecy-le-Vieux  
FR - 74942 Annecy Cedex  
Tel. +33 (0)4 50 64 01 63

**MECALAC BAUMASCHINEN  
GMBH**  
Am Friedrichsbrunnen  
D-24782 Búdelsdorf  
Tel. +49 (0)43 31/3 51-319

**MECALAC CONSTRUCTION  
EQUIPMENT UK LTD**  
Unit 1, Mallory Way  
Gallagher Business Park  
Coventry, CV6 6PB, UK  
Tel. +44 (0)24 7633 9400

**MECALAC İŞ MAKİNELERİ  
SAN. VE TİC. LTD. ŞTİ.**  
Ege Serbest Bölgesi  
Zafer SB Mahallesi Gündüz Sokak No:17/1  
35410, Gaziemir - İzmir - TÜRKİYE  
Tel. +90 232 220 11 15



[WWW.MECALAC.COM](http://WWW.MECALAC.COM)